

P

Pittsburgh

M

ineral &

E

nvironmental

T

echnology, Inc.

NORM IX

Mandatory Air Monitoring of TENORM Worker Inhalation Exposure from Gas TENORM

Alan McArthur

William Lemons

Pittsburgh Mineral and Environmental Technology Inc.

New Brighton Pennsylvania

United States of America

PROBLEMS FROM THE UNDETECTED PRESENCE OF TENORM

- 1. Personnel direct & inhalation exposure to dust or aerosols containing TENORM**
- 2. Environmental and equipment TENORM contamination**
- 3. Rejection of waste by disposal facilities**
- 4. Rejection of scrap by recycle facilities**
- 5. Penalties for Non-compliant transport and shipping manifest errors**
- 6. Unbudgeted costs for remediation of facilities, equipment, pipeline inspection pigging, filters, well workover and waste disposal.**
- 7. Litigation costs subsequent to people exposure & environmental contamination with Non factual records.**

SOURCES AND TRANSPORT OF NORM

- Radium Follows Oil and Gas Liquids, Production and Solids
- Radon Follows Natural Gas Processing, Pipelines, Fractionation Plants and Storage facilities

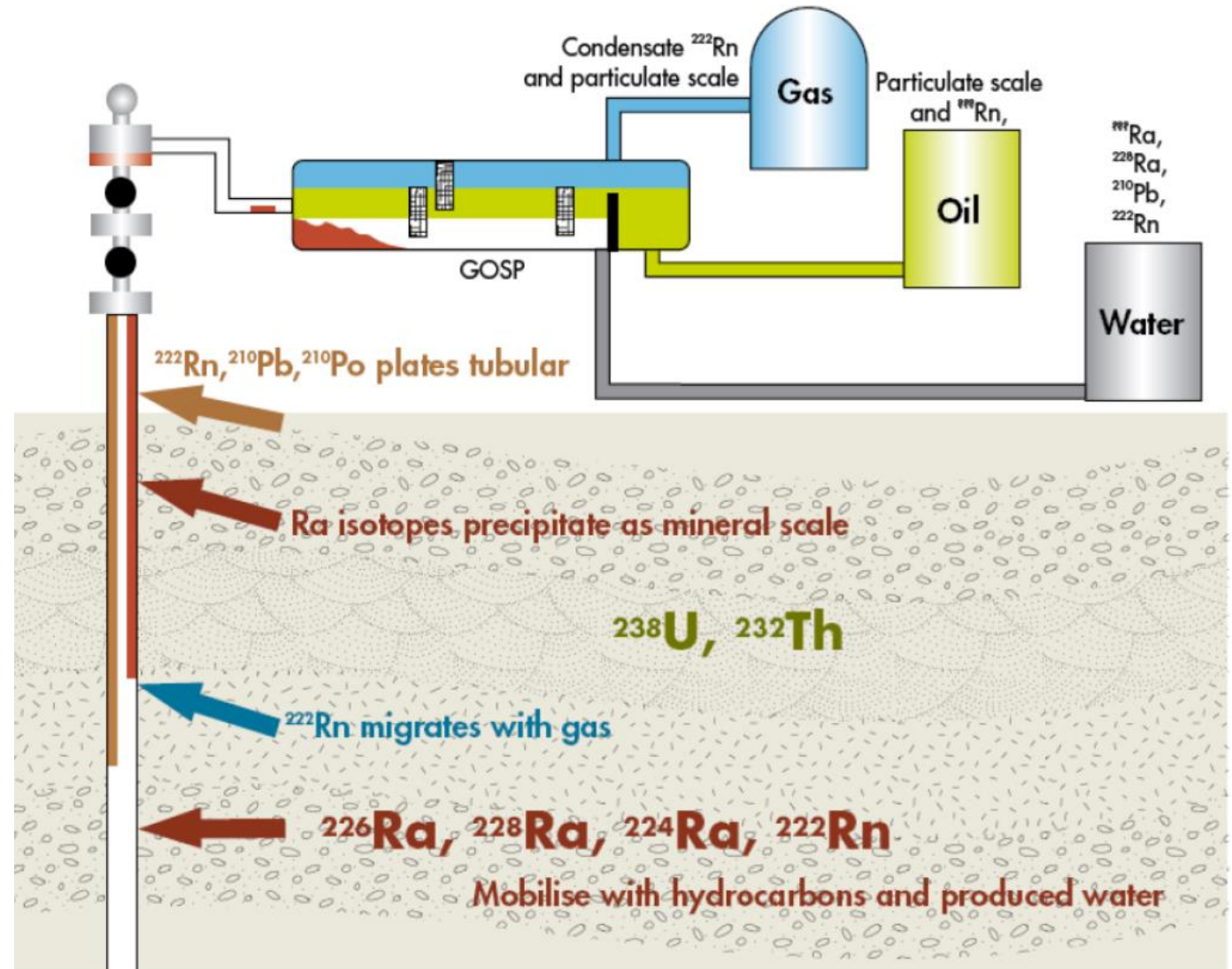

TENORM Solids From Produced Water Lines

Notice how calcite scale buildup clogs the pipe. Ra 226 and Radium 228 precipitate with the scale to become TENORM

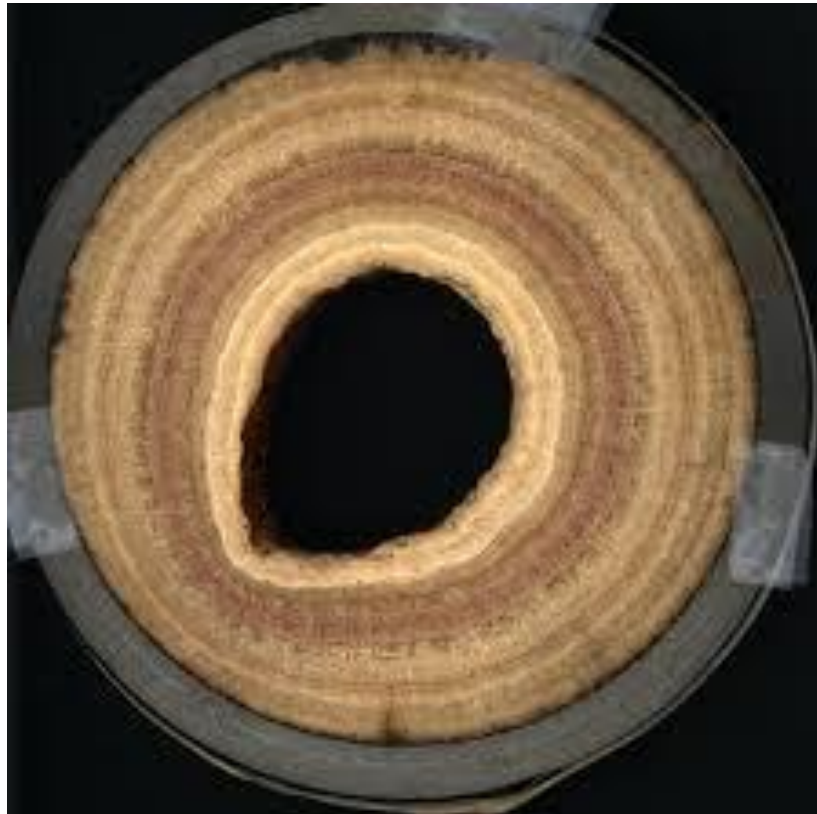

RADON IS THE MAJOR SOURCE OF GAS TENORM SOLIDS

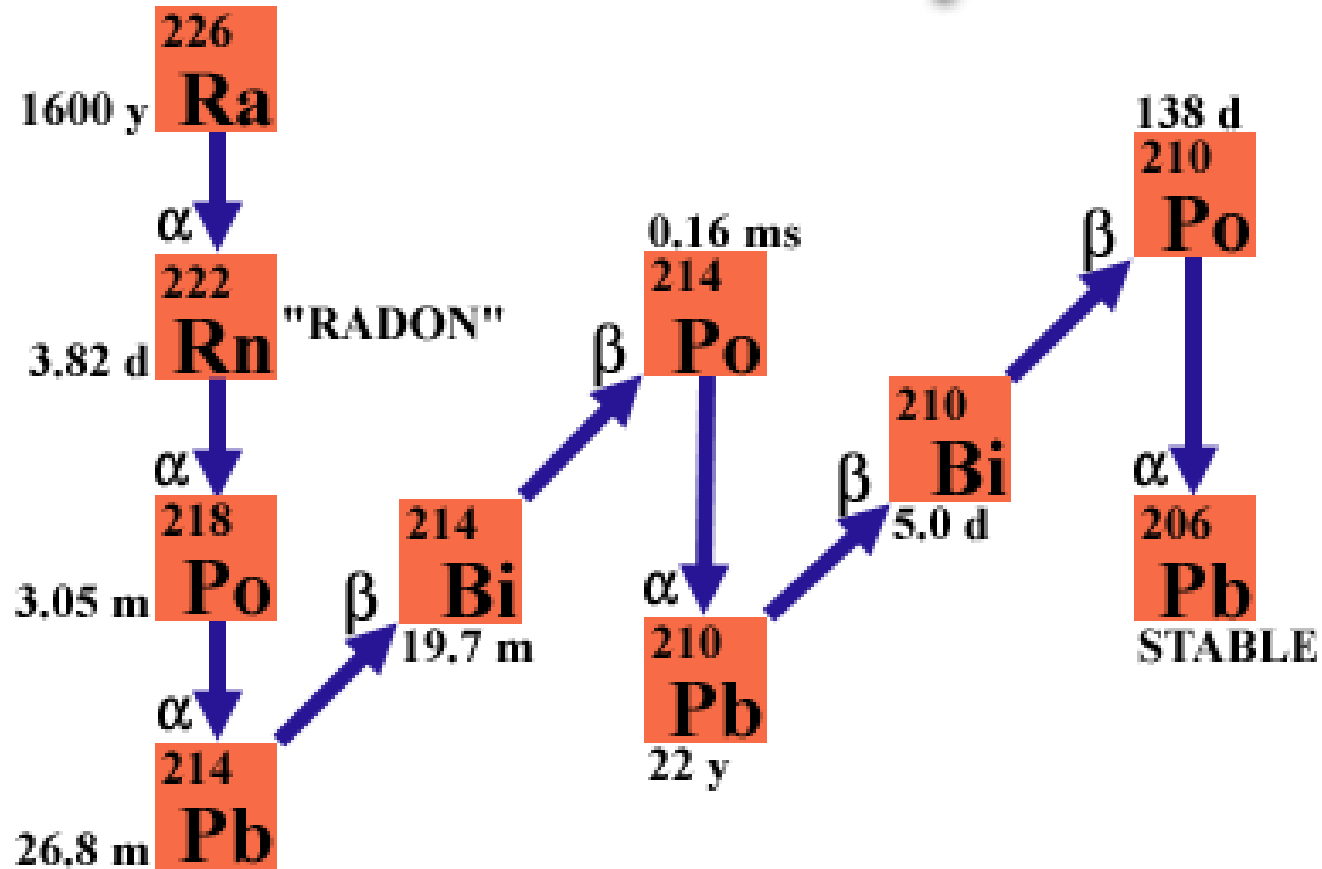

Lead 210, Bismuth 210 and Polonium 210 are the radioactive nuclides of interest in the pipeline.



Radon Video Alpha Particles

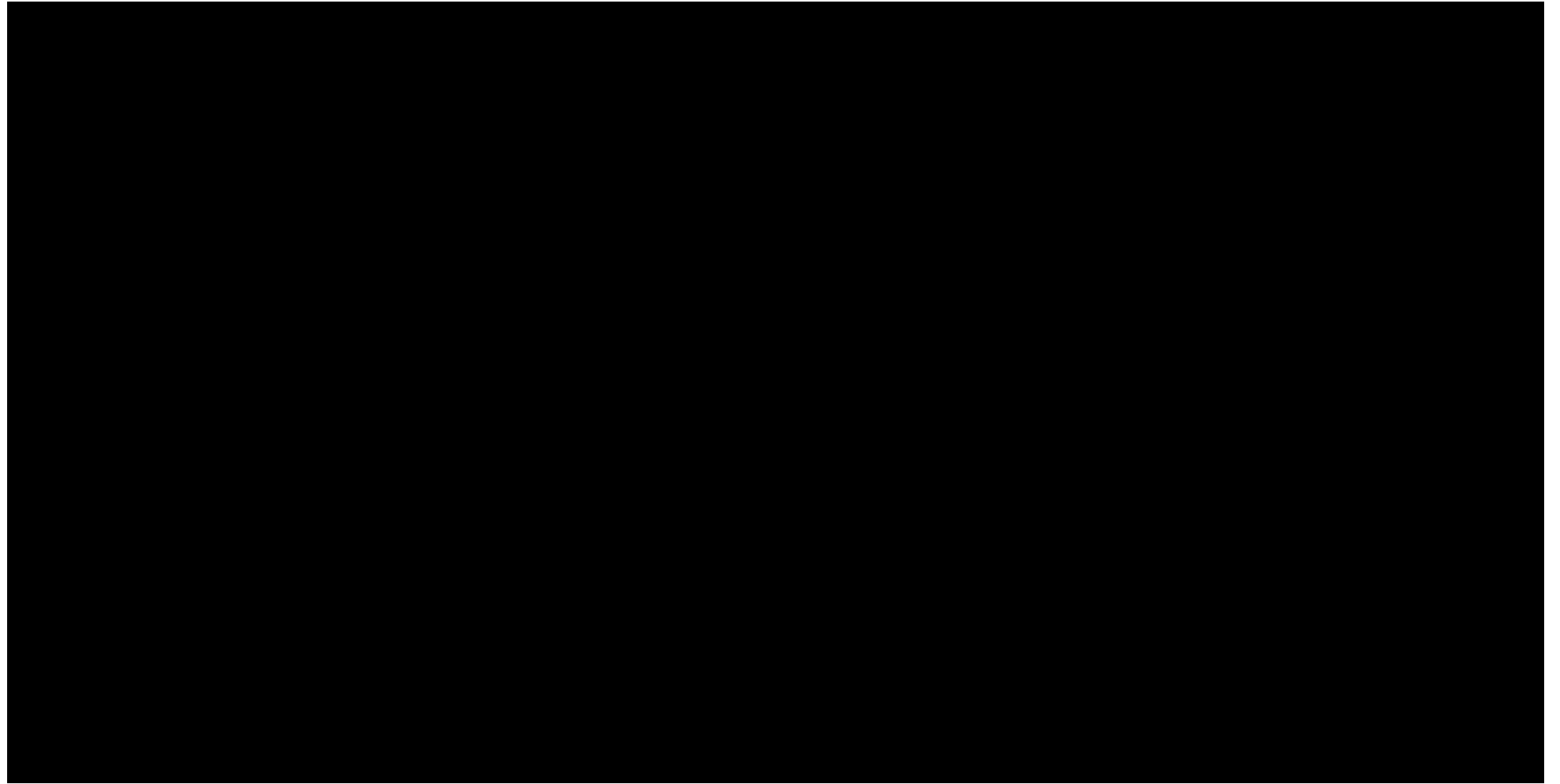

RADON IS THE MAJOR SOURCE OF GAS TENORM SOLIDS

- 1. Radon 222 is ubiquitous in the environment and found in underground mines, homes (particularly basements and crawl spaces), natural gas reservoirs, pipelines, granite buildings and soil gas.**
- 2. Radon in US homes is regulated at 0.15 Bq/L (4 pCi/L)**
- 3. Wellhead gas has been measured up to 4.44 Bq/L (120 pCi/L)**
- 4. Transmission pipelines pressures of 100 times standard temperature and pressure can have up to 444 Bq/L (12,000 pCi/L)**

RADIOACTIVITY INGROWTH IN TRANSMISSION LINE

- **By Compression, the Rn 222 effective concentration increases by almost 100 times**
- **Wellhead 0.37 Bq/l (10 pCi/l) activity (@ STP) of Rn 222 can be 37 Bq/l (1000 pCi/l) at 9.6 M pascals (1400 psi)**
- **Radon 222 has a 3.82 day half life and decays to Pb, Bi and Po 210**
- **Po 210 is essentially in equilibrium with Pb 210 and both bond with particulates and pipeline surfaces.**
- **Concentrated particulates collect on pigs, filters, and inner surfaces of pipes, valves, etc.**
- **Pigs and filters may become highly contaminated during pigging operations with particulate containing Pb 210 and Po 210**

RADON IS CONCENTRATED BY THE FOLLOWING

- **Compression – as much as 100 times 0.37-37 Bq/L (10 increased to 1000 pCi/L)**
- **Fractionation -- Variable, increase up to 100 times**
- **Condensation -- ~265 times for propane**
- **Ingrowth and Depositions of Particulates – > 10000 times
Resulting in Concentration of TENORM**

LEAD, BISMUTH & POLONIUM 210 IN INGROWTH IN A PIPELINE

- **Assumptions and calculations**
- ***Corrected Compression Factor*** = **97.75**
- **Diameter of Pipeline** = **42.0 Inches**
- **Length of Pipe Line Section** = **500 Miles**
- **Total Volume for 500 Miles of Pipeline** = **25399777 ft³**
- **Natural Gas Flowrate** = **2,500,000,000 Cu Ft/Day**
- **Pipe Pressure** = **1400 PSI**
- **Velocity of Gas Through the Pipe Line** = **21 Miles/Hour**
- **Rn 222 Activity @ STP** = **0.37 Bq/L (10 pCi/L)**
- **Avg Radon Content for 500 miles =**
in = **26,012 MBq (703,035 μCi)**
the Pipeline

RADIOACTIVITY IN-GROWTH IN A 500 MILE TRANSMISSION LINE

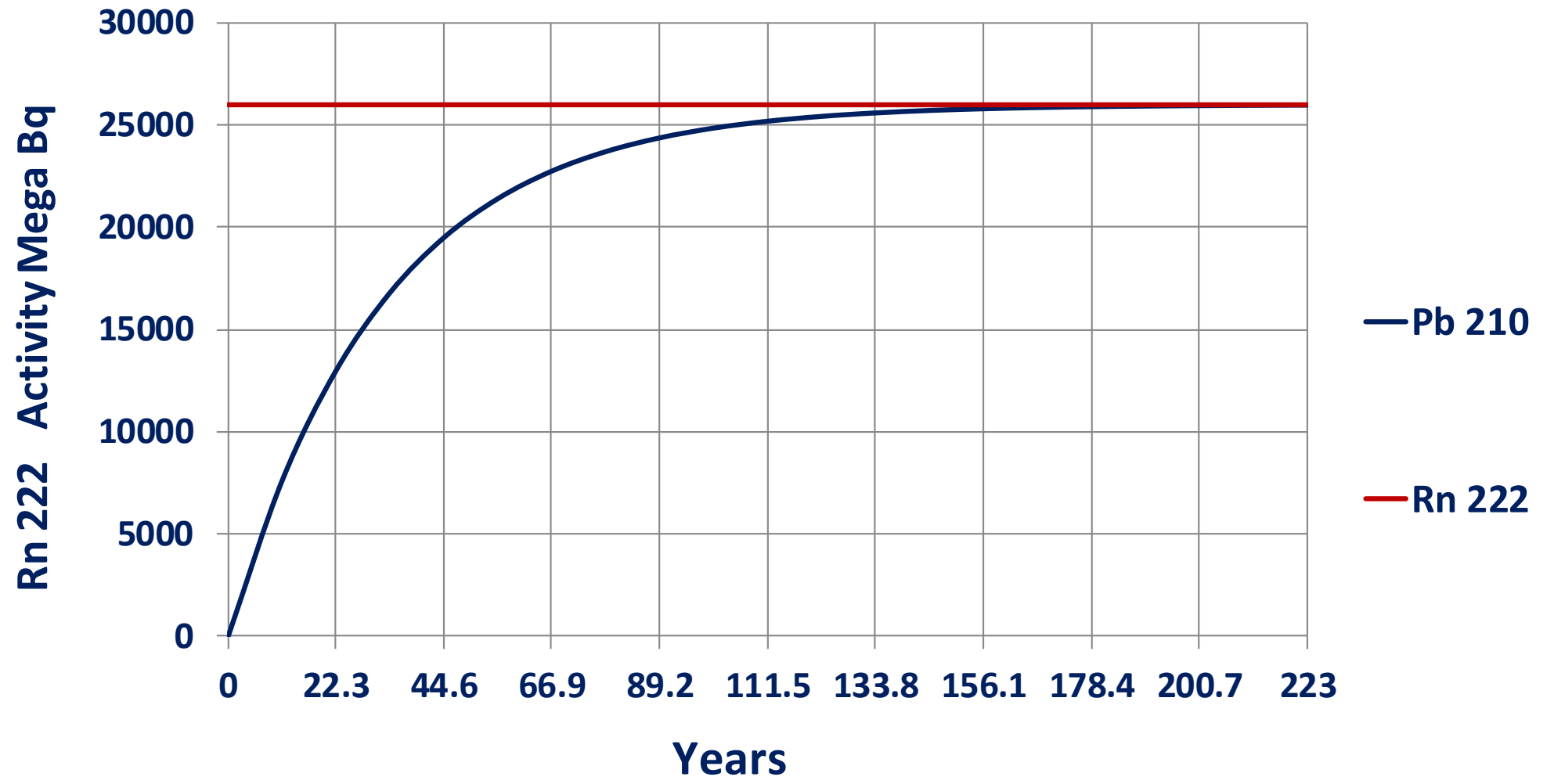

RADIOACTIVITY IN-GROWTH IN A 500 MILE TRANSMISSION LINE

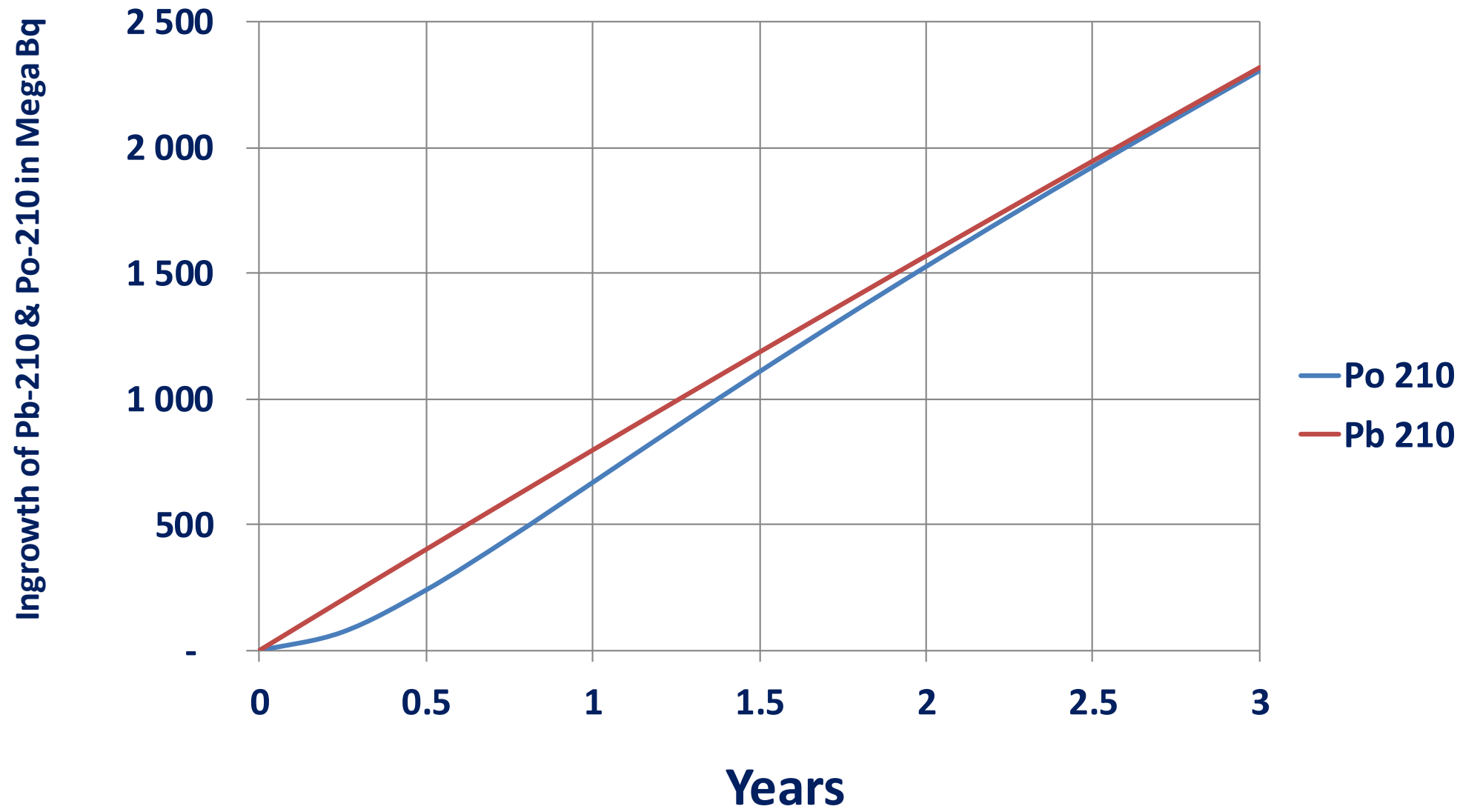

GAS PIPELINE PROCESS PLANT TERMINAL FILTER POT

Gas pipeline filter solids Lead Bismuth and Polonium 210
Specific activity measured 0.044 $\mu\text{Bq/g}$ (**1.2 $\mu\text{Ci/g}$ Po-210**)

**6 $\mu\text{Sv/h}$ (600 $\mu\text{R/hr}$)
Bremsstrahlung X-Ray
Radiation**



GAS PIPELINE PROCESS PLANT TERMINAL FILTER POT

Gas pipeline filter solids Lead Bismuth and Polonium 210
Specific activity measured 0.044 $\mu\text{Bq/g}$ (**1.2 uCi/g Po-210**)

**Gas pipeline in line
filters contaminated
with solids**

**Lead 210/
Bismuth 210/
Polonium 210**

**Loose Radioactive
particulates**



GAS PIPELINE FILTER POT CLEANING



NORM Worker replacing the filter containing radioactive Lead 210, Bismuth 210 and Polonium 210 . Notice the “Level C” Personal Protective equipment. TENORM Workers must be monitored after every activity.

TENORM CONTAMINATED PIPELINE PIGS

12 inch smart pig



20 inch smart pig

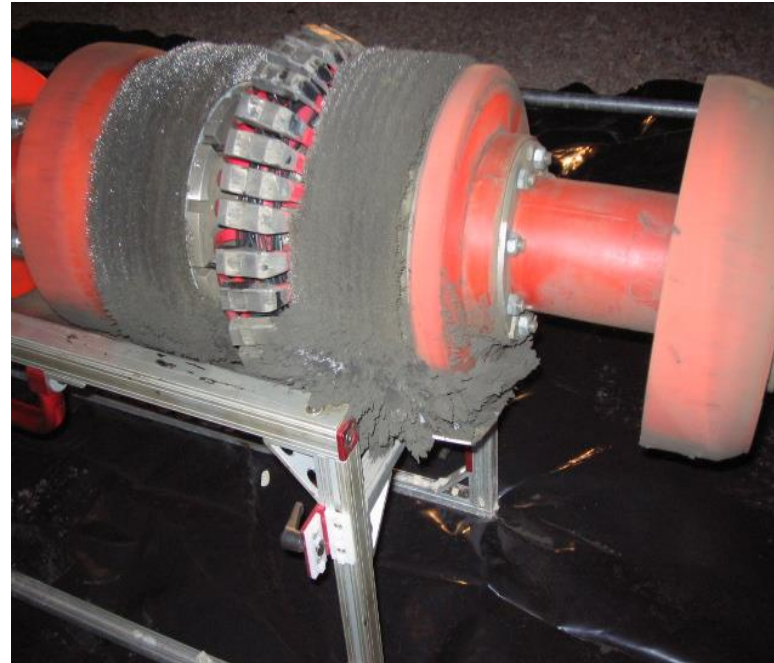

Operational foam pigs



Radon Transport; Lead, Bismuth and Polonium 210 Deposition

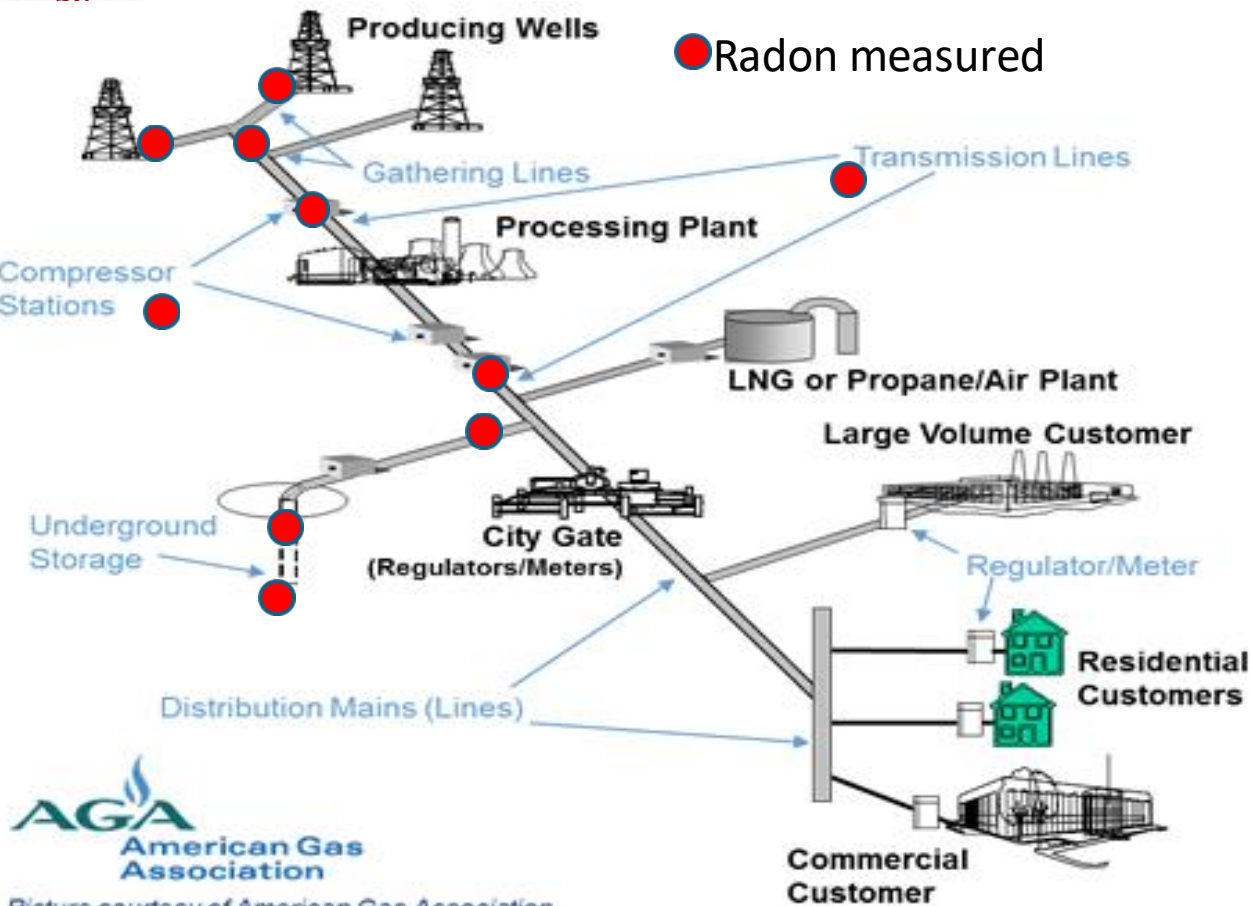

- Gas Producing Wells, Rn 222 levels from 0.07-4.44 Bq/L (2 to 120 pCi/L (STP))
- LNG / Propane Lower Radon in Methane, much higher Radon in Propane (possibly Ethane)
- Underground storage could recharge Radon in dry Natural Gas.
- Radon Daughters Pb, Bi and Po 210 particulates are deposited in Pumps, pipelines, vessels and filters, storage reservoir equipment.
- Equipment inspection, cleaning and Refurbishment; worker safety / waste management is a concern.

FRACTIONATION OF THE NATURAL GAS COMPONENTS

TENORM
Deposits ●

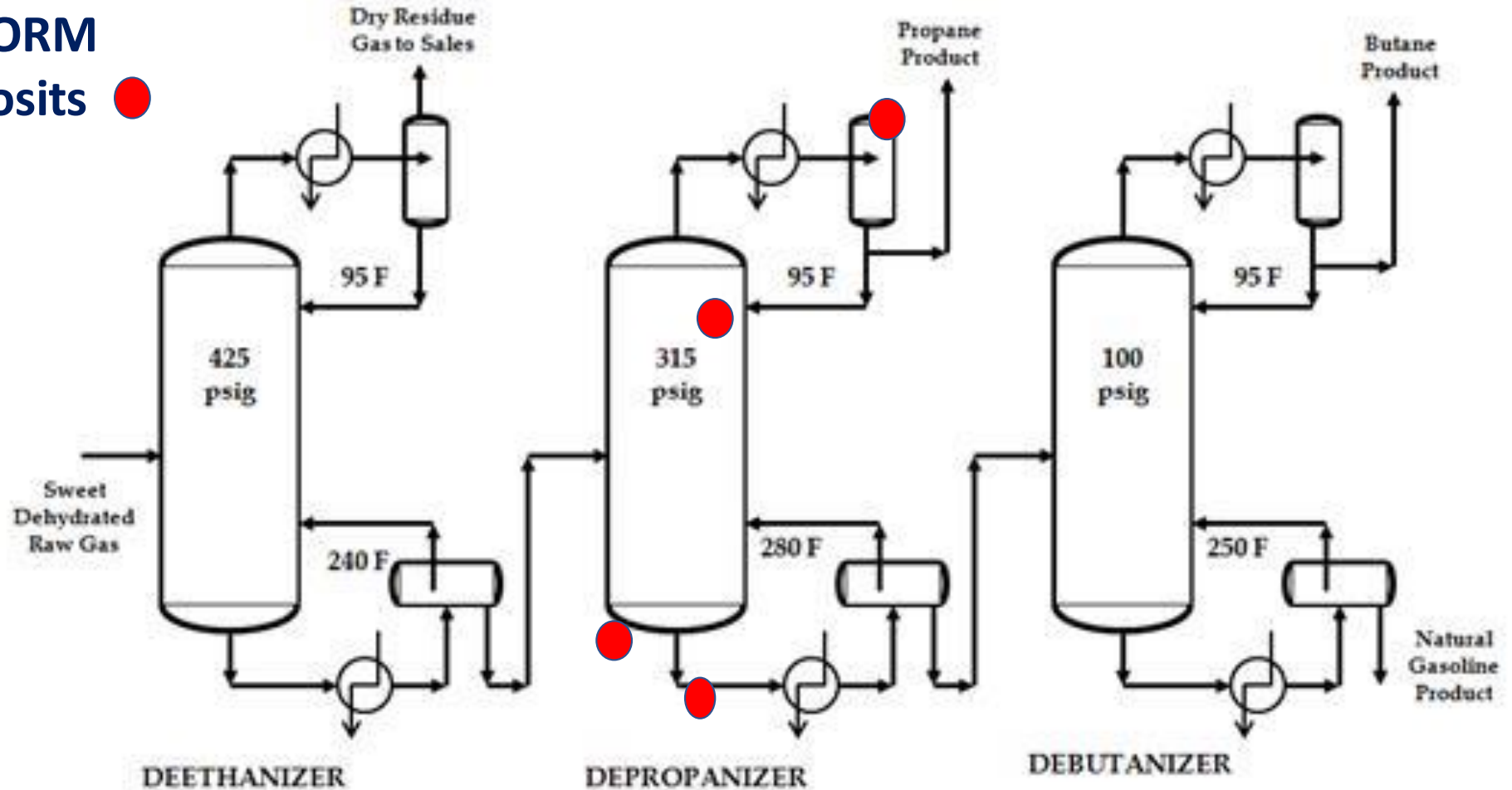

UNDERGROUND GAS STORAGE CONCERNS

- TENORM is found in storage well Equipment & tubulars.
- Large surface Propane tanks may become TENORM contaminated.

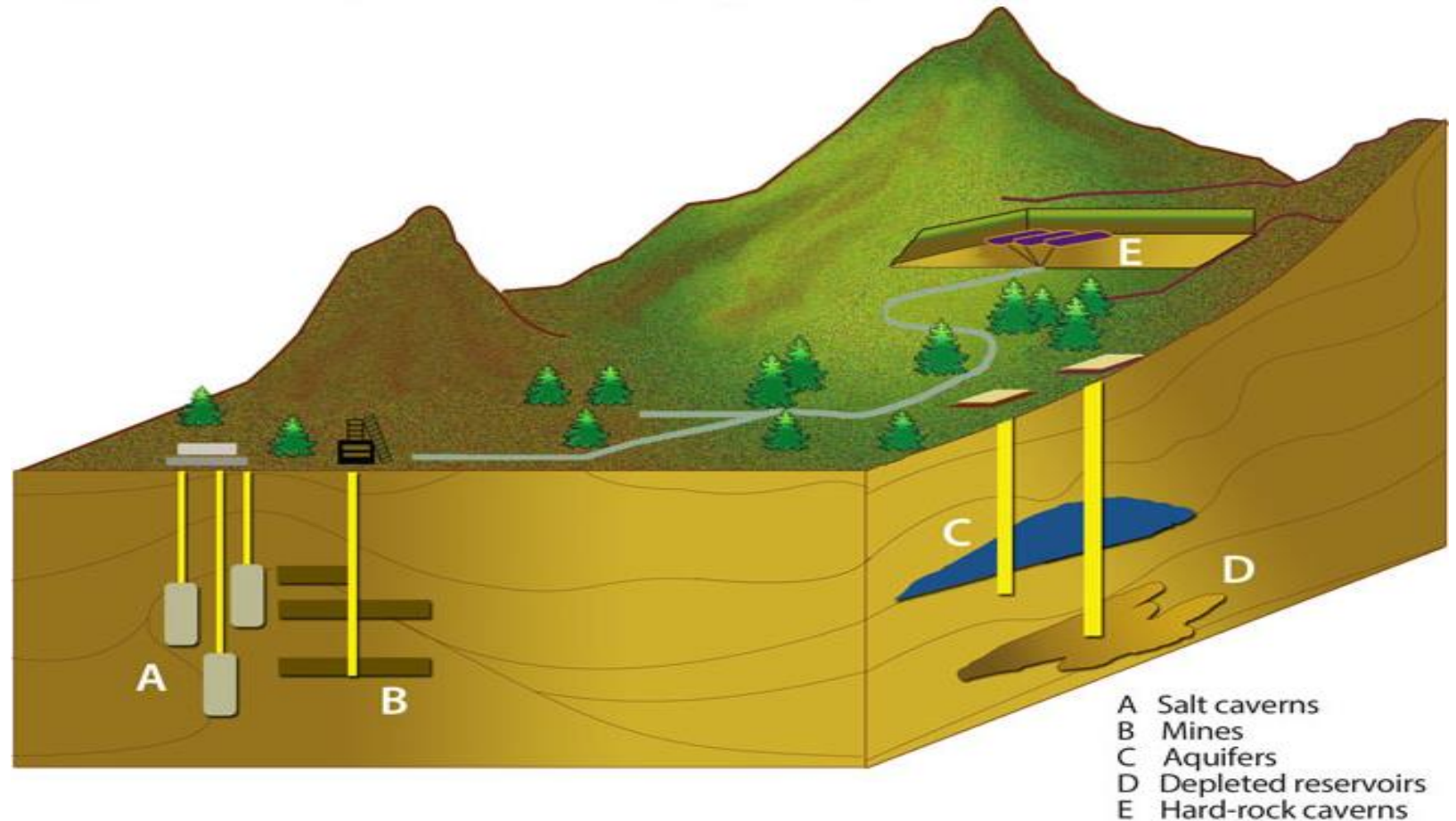

Source: PB-KBB, inc., enhanced by EIA.

Gas Cavern Well Casing Cleaning



TENORM cleaning gas **storage cavern** well tubulars and casings prior to inspection. Secondary containment protects site work area.

- **FACTS ABOUT GAS TENORM and POLONIUM 210**

- The radioisotope Polonium-210 (Po-210) decays to lead (Pb-206) by emitting high energy (5.3 Mev) alpha particles that can kill body cells
- The inhalation and or ingestion of Po-210 into the body can cause irradiation of internal organs by the alpha particles.
- The **alpha** particles can be stopped by **external skin** layer of the body washed off.
- **Beta** particles can **penetrate up to 1 centimeter** of body tissue.

FACTS ABOUT GAS TENORM and POLONIUM 210

- **Gamma rays deposit energy** in each cell as they **pass through the body.**
- **The toxicity of Po-210 is much higher than that of cyanide. (10,000)**
- **Good personal hand-washing and showering will clean external alpha contamination.**
- **Polonium-210 can concentrate to very high concentrations in Gas collecting on pipelines, all pig types & gas filters, separation and processing plants.**

SPECIFIC ACTIVITY OIL COMPARED TO GAS TENORM

OIL

0.2 – 1,111 Bq/g, (5 - 30,000 pCi/g), Total Specific Activity.

Main Isotopic concentration found in Radium 226

GAS

122,222 Bq/g, (3.3 million pCi/g) Total Specific Activity

Main isotopes are: Lead-210, Bismuth-210 and Polonium-210

Frequency of Specific Activites for Oil and Gas NORM

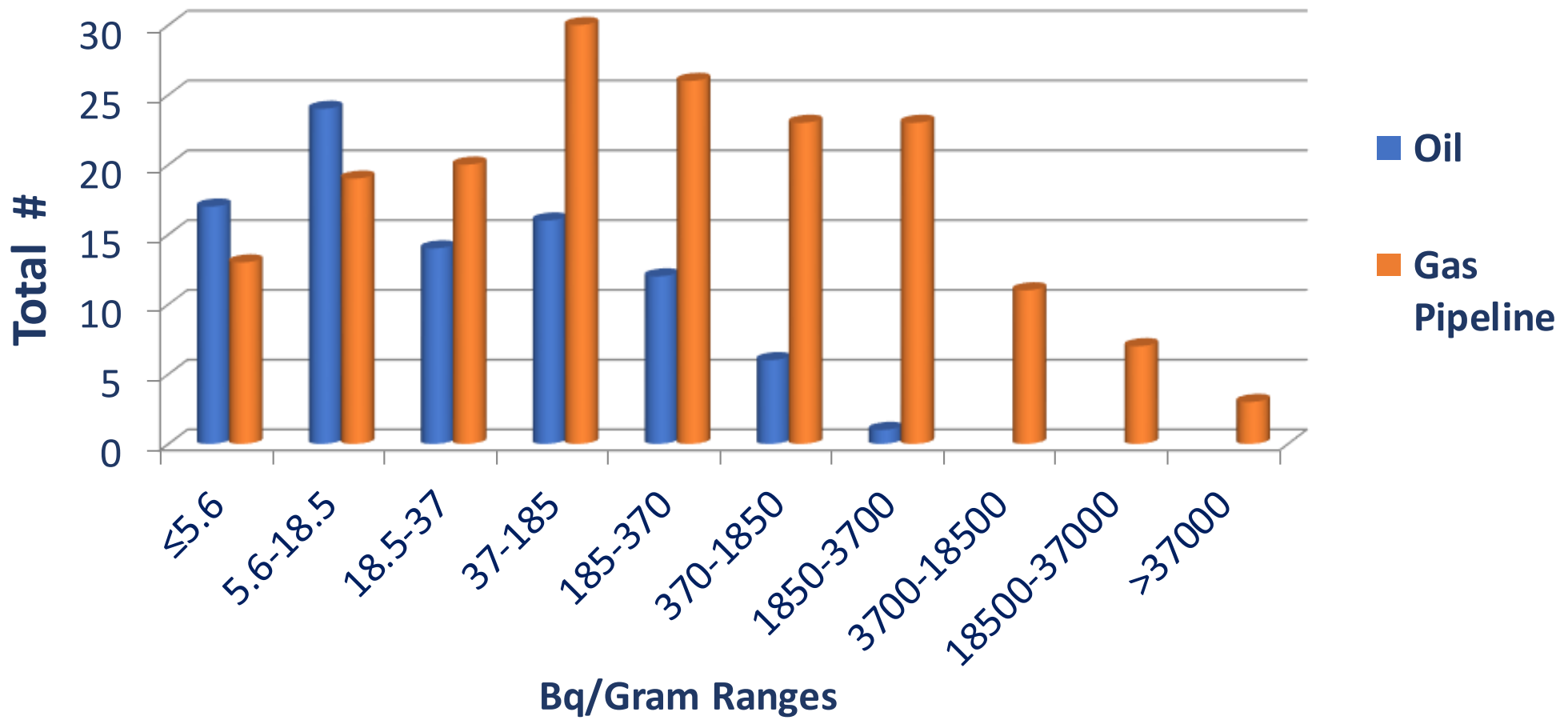

Air Monitoring requirement for GAS TENORM Workers

- **Annual TEDE Radiation = External Exposure + Internal Inhalation**
- **External gamma dose rate < 0.02mSv/hr (2 mrem/hr)**
- **Maximum External annual US dose = 0.15 mSv p.a. (15 mrem)**
- **Maximum Inhalation Annual Exposure = 70 mSv p.a. (7000 mrem)**

Inhalation exposure could be 47 times the external exposure

Gas TENORM Sample Analysis Results for Lead 210

US regulation Occupational Inhalation Derived Air Concentration (DAC)

								DAC	% >
Isotope	Run	Type	Client ID	Units	Result	Uncertainty	MDA	uCi/ml	DAC
Lead 210	1	LCS	LCS	uCi/ml	3.67E-04	8.61E-06	4.57E-07		
Lead 210	1	MBL	BLANK	uCi/ml	-9.55E-14	6.21E-13	1.62E-12		
Lead 210	1	DUP	A10007-1	uCi/ml	1.40E-10	3.97E-12	4.97E-13	1.00E-10	140 %
Lead 210	1	DO	A10007-1	uCi/ml	1.39E-10	4.02E-12	5.77E-13	1.00E-10	139 %

Note DAC + 40%



INHALATION EXPOSURE IN GAS TENORM REMEDIATION PROJECTS HAS BEEN MEASURED AT 47 TIMES GREATER THAN HIGHEST EXTERNAL GAMMA EXPOSURE DOSE

- Annual Inhalation exposure 0.07 Sv (7 rem)
- Annual External OSL Dose measured maximum annual exposure 0.15 mSv, (15 mrem).

Note: OSL is Optically Simulated Luminescence

CONCLUSIONS FOR GAS TENORM

- 1. Inhalation/Ingestion of GAS TENORM must be prevented.**
- 2. GAS TENORM workers must wear fit tested respirators.**
- 3. Respiratory air and public air monitoring is required on ALL Gas TENORM projects.**
- 4. Gas TENORM dust can exceed the regulatory Derived Air Concentration by up to 40%.**
- 5. The annual TENORM Worker TEDE would be 0.07 Sv (7 rem) from dust and/or aerosol inhalation alone.**
- 6. High Pressure gas pipelines can have 26,000 M Bq of concentrated TENORM.**

CONCLUSIONS FOR GAS TENORM

- 7. GAS TENORM creates liability requiring Policy and Regulatory Compliance & Reporting**
- 8. OSHA requires TENORM Detection & Evaluation for Worker Protection Programs.**
- 9. Worker exposures MUST be ALARA and < 0.05 Sv (5 rem) per year.**
- 10. Air monitoring is REQUIRED by regulation to calculate and report workers annual TEDE exposure.**

CONCLUSIONS FOR GAS TENORM

- 11. Gas TENORM Waste sample & analysis is critical to manage Disposal costs.**
- 12. Regulations require TENORM records are kept safe for liability management and reporting..**
- 13. A General Radioactive Materials License is issued automatically to companies in Possession of regulated TENORM. Compliance with ALL RAM Regulations is required.**

Pittsburgh
Mineral &
Environmental
Technology, Inc.



THANK YOU!